

Industrial 3-blade ceiling fan HVLS3

COD: SLHS000000000000



HVLS 3-Blade Industrial Ceiling Fans.

- 3 Blades Extruded in Anodized Aluminum against Corrosion with Constant Cross Section
- Precabled 3-phase Brushless EC motor equipped with Integrated Electronic System and EMC3 filters
- Sizes with Diameters 2.4m / 3m / 3.6m
- Air Flow Rates up to 134,271 m³/h (AMCA230-99)200
- Max RPM
- Pot. Max Ass. 0.7 kW
- Suitable for continuous duty S1.



Insight

HVLS in Italian stands for HIGH FLOW LOW RPM

These are large-scale industrial ceiling fans whose unique technical features can greatly improve summer comfort and winter energy conservation. They can move huge air flow rates and do so at low revolutions. They are an excellent alternative to coolers because they do not affect the ambient humidity level, while still creating a pleasant feeling in operators.

CONSTRUCTION

Upper structure protecting the motor made of welded and painted steel.

The fan is equipped with:

- Decorative canopy to cover electrical cables and brackets for ceiling mounting.
- Safety cable set and tubular L = 800mm supplied.
- Blades made of aluminum EN AW 6063 T6 with anodized treatment against corrosion.
- Aerodynamic blade terminals made of black plastic.
- Hub provided with safety ring.
- Aesthetic hub cover made of black plastic.
- Available in **three sizes: 2,400mm to 3,600mm with air flow rates up to 114,000m³/h.**
- High-efficiency three-phase brushless EC motors specifically designed for HVLS fans, 200-480Vac/3ph/ 50/60Hz, IP65, equipped with integrated electronics and EMC filters.
- Suitable for continuous duty S1

FEATURES AND BENEFITS

- Absence of gears and aerodynamic design to ensure absolute silence.
- Optimization of HVAC systems and reduction of CO₂ emissions, consumption and energy costs.
- Winter comfort achieved by bringing down the heat that stratifies at the top of the rooms, equalizing the temperature and avoiding further heating.
- Summer comfort achieved by keeping the air moving continuously, eliminating annoying hot-cold zones and creating a gentle breeze that promotes natural transpiration and drives away annoying insects.
- No routine maintenance required.
- Steel structure to ensure long life, strength and sturdiness.
- Several systems provided to ensure maximum safety (reinforced main safety cable, additional stabilization cables, hub safety ring).
- Aerodynamic blade terminals to optimize performance and acoustic comfort.
- Hub cover for dust protection and improved design.
- Simplified electrical connections: pre-wired.
- Integrated EMC filters to prevent possible electromagnetic interference with other devices.
- Fans suitable for operation at temperatures from 0°C to +50°C.
- Units are tested in accordance with the latest AMCA standards to ensure maximum reliability of performance data.
- Designed and manufactured according to the Machinery Directive (MD), Low Voltage Directive (LVD) and Electromagnetic Compatibility Directive (EMC).



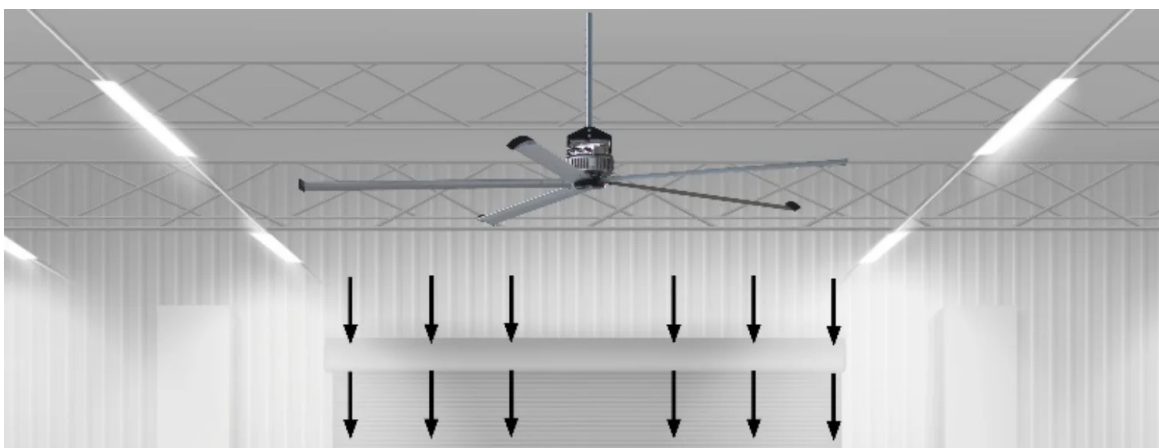
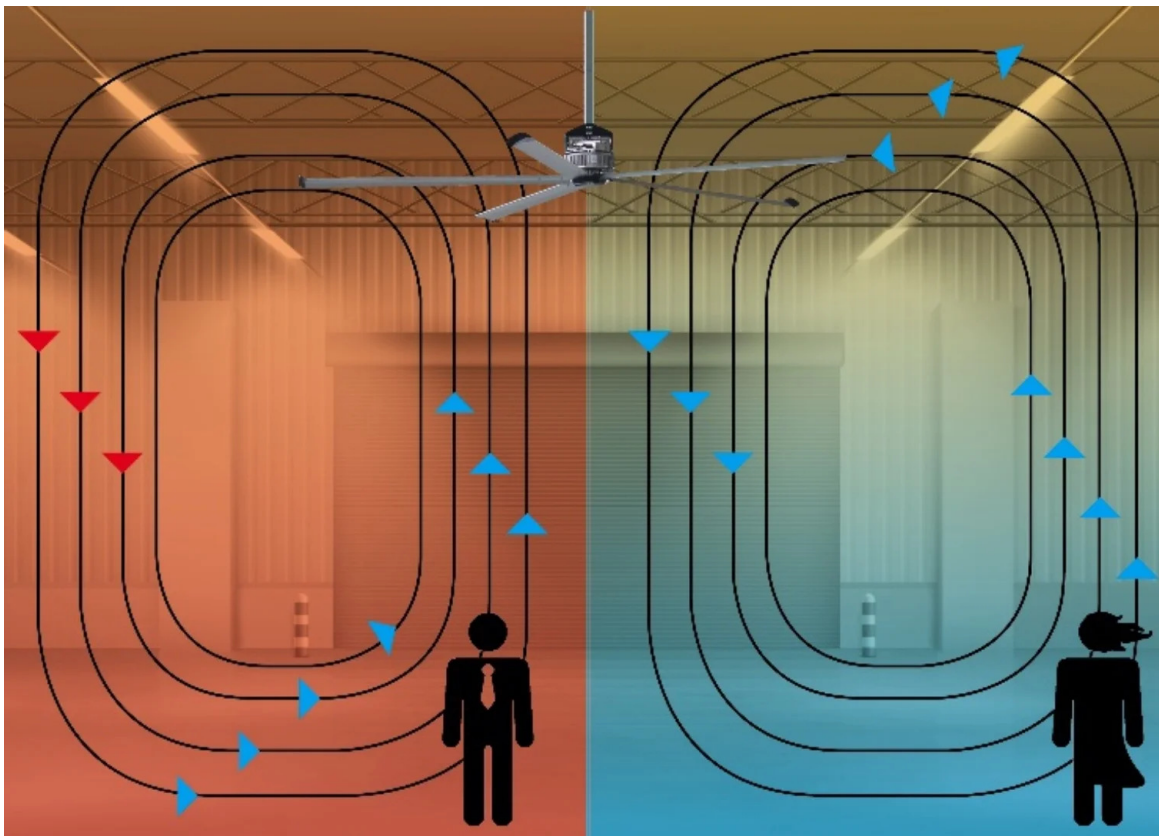
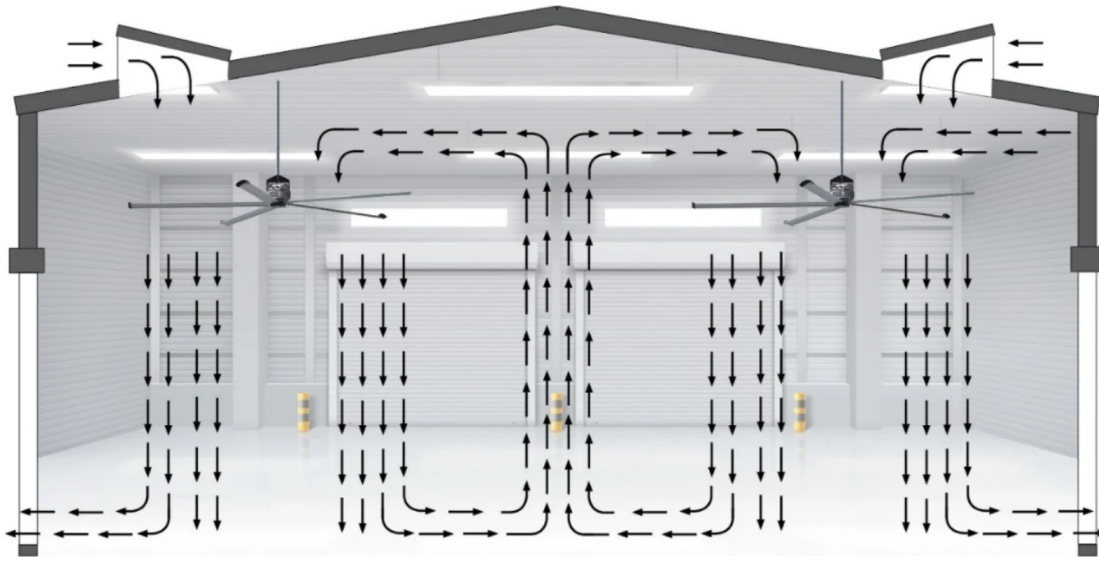

Dimensions

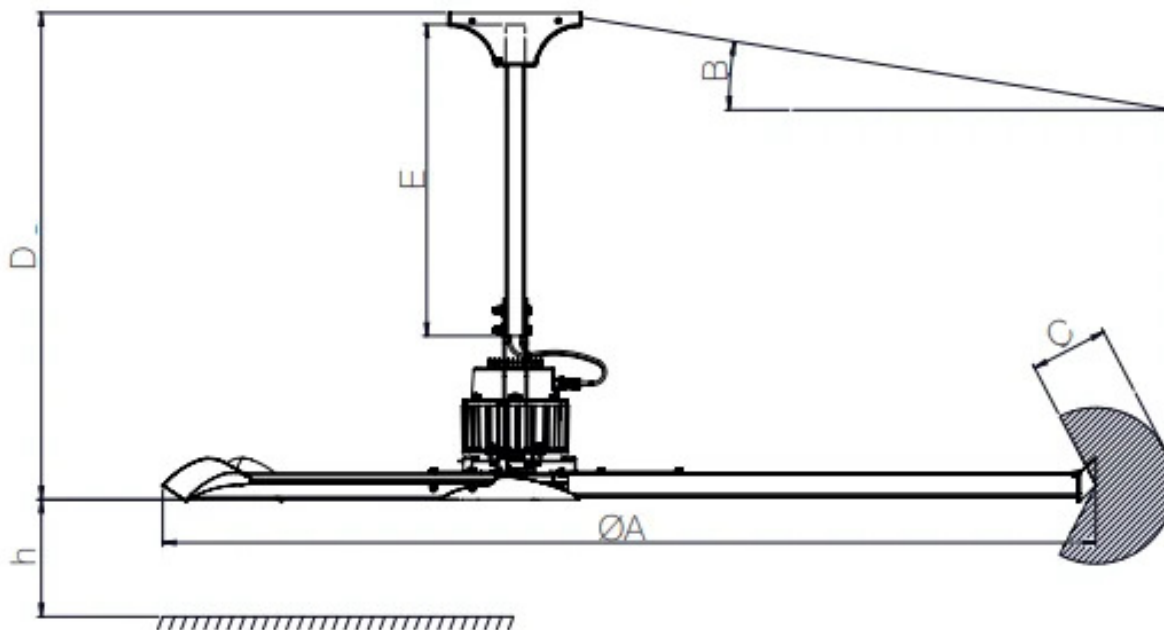

Code	A mm	B mm	C mm	D mm	E mm	h mm
SLHS24000000000	2400	20	350	1250	800	2700
SLHS30000000000	3000	20	350	1250	800	2700
SLHS36000000000	3600	20	350	1250	800	2700



Technical Data

Code	Diameter mm	Power kW	Power W	Nominal flow rate m ³ / h	Weight kg	Power supply Hz	Motor	RPM rpm
SLHS24000000000	2400	0,7	700	93256	62	50/60	Three-phase	200
SLHS30000000000	3000	0,45	450	113921	64	50/60	Three-phase	130
SLHS36000000000	3600	0,38	380	134271	67	50/60	Three-phase	110



Photogallery

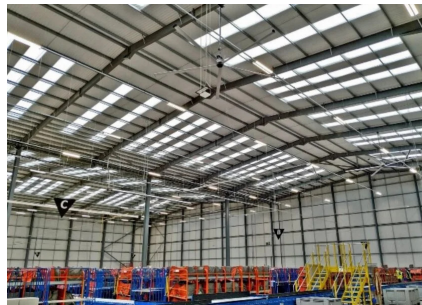
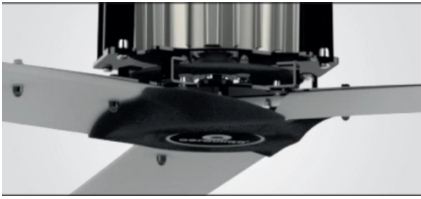

Related accessories



3.5" touch control panel with color graphic display

PNLNCTR35000000

3.5" touch control panel with color graphic display that can control up to 4 units.



Control panel with temperature probe included and humidity probe on request

PNCSNDUMID00000

Controller to control ventilation units according to temperature degree and THI level.



Control panel with anemometer and probe for temperature measurement

PNCANEMSND00000

Controller to control ventilation units according to the degree of temperature and wind speed.



Potentiometer equipped with a bipolar ON/OFF switch

POTINTBIP000000

Remote potentiometer with front knob for manual adjustment of fan speed provided with two-pole switch (ON/OFF) and yellow front LED.

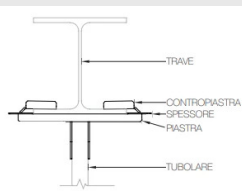

IPE/HEA/HEB beam fastening kit

KITIPEHEAHEB000

Fastening kit for SMHS fans in HVLS version compatible with most popular IPE, HEA, HEB steel profiles.



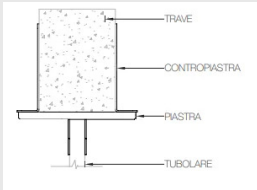

Fixing kit for rectangular section beams

KITRETTANGOL000

Fixing kit for SMHS fans in HVLS version compatible with rectangular section beams with base between 100mm and 260mm.



Related Products



HVLS industrial 5-blade ceiling fan APBG5S

SWHS000000000000

HVLS Industrial 5-Blade Ceiling Fan APBG5S

- 5 Blades Extruded Aluminum Shaped Profile
- Narrow Cone Air Distribution
- Three-phase Brushless EC motor equipped with Integrated Electronic System and EMC filters 3
- Sizes with Diameters 4m / 5m / 6m
- Air Flow Rates up to 529,464 m³/h (AMCA230-99)
- 120 RPM Max
- Pot. Max Ass. 1.4 kW
- Suitable for continuous duty S1



HVLS industrial 5-blade ceiling fan APBG5

SMHS000000000000

APBG5 5-Blade Industrial Ceiling Fan

- 5 Blades Extruded Aluminum Anodized Against Corrosion Constant Section
- Increased Air Distribution Cone
- Three-phase Brushless EC motor equipped with Integrated Electronic System and EMC filters
- 3 Sizes with Diameters 3.6m / 5.4m / 7.3m
- Air Flow Rates up to 438,818 m³/h (AMCA230-99)
- 110 RPM Max
- Pot. Max Ass. 0.75 kW

