

HVLS industrial 5-blade ceiling fan APBG5

COD:

SMHS000000000000



APBG5 5-Blade Industrial Ceiling Fan

- 5 Blades Extruded Aluminum Anodized Against Corrosion Constant Section
- Increased Air Distribution Cone
- Three-phase Brushless EC motor equipped with Integrated Electronic System and EMC filters
- 3 Sizes with Diameters 3.6m / 5.4m / 7.3m
- Air Flow Rates up to 438,818 m³/h (AMCA230-99)
- 110 RPM Max
- Pot. Max Ass. 0.75 kW



Insight

HVLS stands for **HIGH FLOW LOW RPM** in Italian

These are large-scale industrial ceiling fans whose unique technical features can greatly improve summer comfort and winter energy savings. They can move huge air flow rates (up to 540,000 cu m/h) and do so at low RPM (maximum 110 RPM) . They are an excellent alternative to coolers because they do not affect the ambient humidity level, while still creating a pleasant feeling in operators.

Available in three sizes: from 3,600 mm to 7,300 mm with air flow rates up to 440,000m³/h.

The complete SMHS fan comes with the corresponding Blade Kit + Motor Kit.

CONSTRUCTION

Upper structure to protect the motor made of painted steel.

The fan is equipped with:

- Safety cable set and tubular L = 800mm supplied.
- Blades made of aluminum EN AW 6063 T6 with anodized treatment against corrosion.
- Hub provided with safety ring.
- Aesthetic hub cover
- High efficiency three-phase brushless EC motors designed for HVLS fans, 380-440Vac/3ph/ 50/60Hz, IP55, equipped with integrated electronics and EMC filters. Suitable for continuous duty S1. Adjustable speed

FEATURES AND BENEFITS

- Wide air distribution cone under the fan.
- Absence of gears and aerodynamic design to ensure absolute silence.
- Optimization of HVAC systems and reduction of CO₂ emissions, consumption and energy costs.
- Winter destratification achieved by bringing down the heat that stratifies at the top of the rooms, equalizing the temperature and avoiding further heating.
- Summer comfort achieved by keeping the air moving continuously, eliminating hot-cold zones.
- No routine maintenance required.
- Steel structure to guarantee long life, strength and robustness.
- Several systems provided to ensure maximum safety (reinforced main safety cable, additional stabilization cables, hub safety ring).
- Hub cover to protect the motor from dust and for better design.
- Simplified electrical connections.
- Built-in EMC filters to prevent possible electromagnetic interference with other devices.
- Operate in temperatures from 0°C to +50°C.
- Units are tested in accordance with the latest AMCA standards to ensure maximum reliability of performance data.
- Designed and manufactured in accordance with the Machinery Directive (MD), the Low Voltage Directive (LVD) and the Electromagnetic Compatibility Directive (EMC)



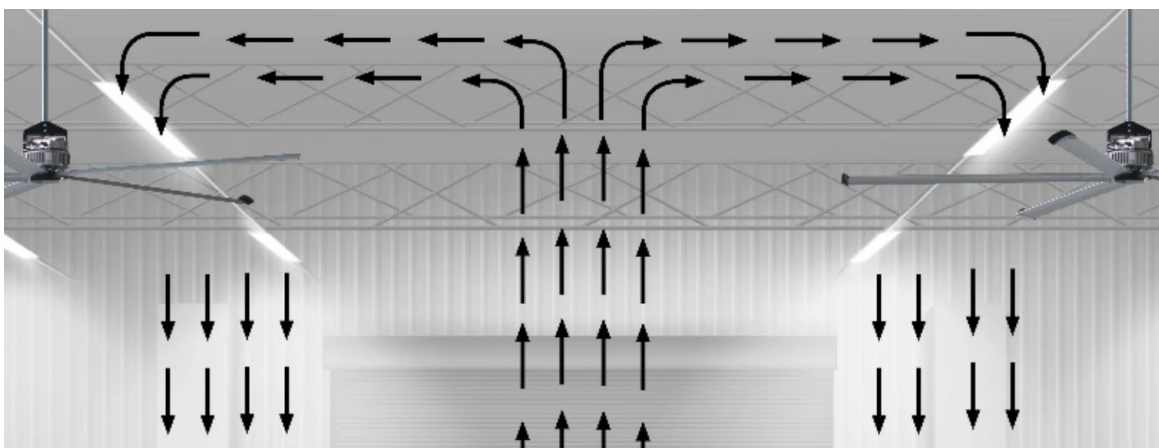
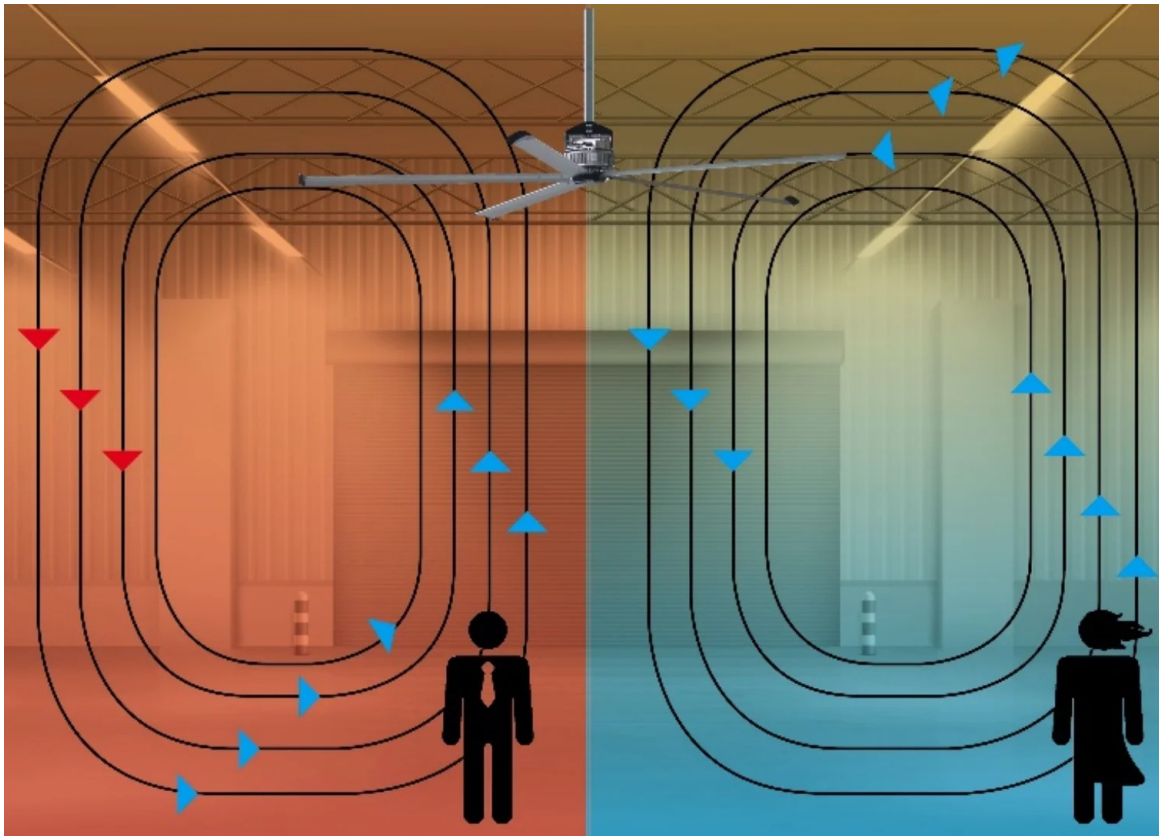
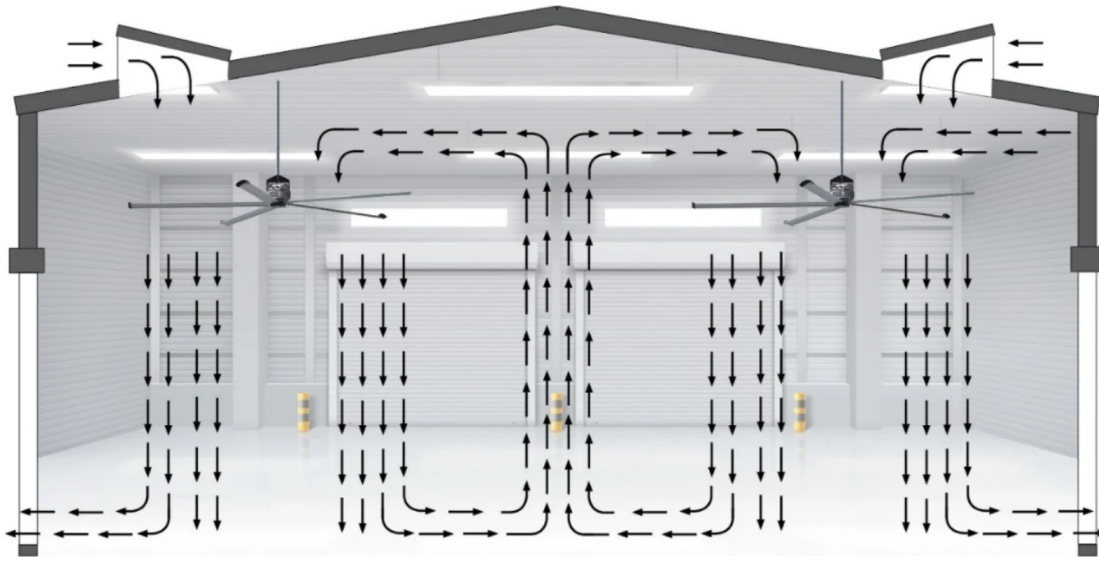

Dimensions

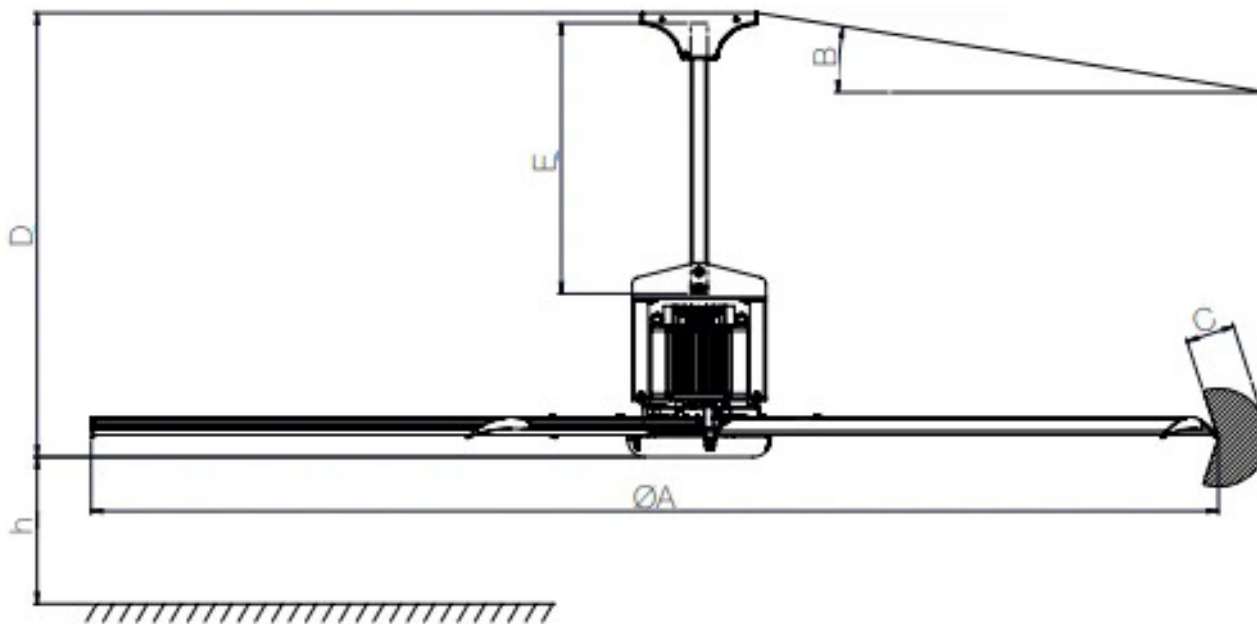

Code	A mm	B mm	C mm	D mm	E mm	h mm
SMHS36000000000	3610	20	550	1315	800	2700
SMHS54000000000	5410	20	650	1315	800	2700
SMHS73000000000	7300	20	750	1315	800	2700



Technical Data

Code	Power kW	Nominal flow rate m ³ / h	Weight kg	Power supply Hz	Motor	RPM rpm
SMHS36000000000	0,57	163105	97	50/60	Three-phase	110
SMHS54000000000	0,66	283089	123	50/60	Three-phase	65
SMHS73000000000	0,75	438818	142	50/60	Three-phase	43



Photogallery

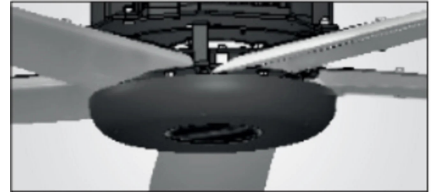

Related accessories



3.5" touch control panel with color graphic display

PNLNCTR35000000

3.5" touch control panel with color graphic display that can control up to 4 units.



Potentiometer equipped with a bipolar ON/OFF switch

POTINTBIP000000

Remote potentiometer with front knob for manual adjustment of fan speed provided with two-pole switch (ON/OFF) and yellow front LED.



Control panel with anemometer and probe for temperature measurement

PNCANEMSND00000

Controller to control ventilation units according to the degree of temperature and wind speed.



Control panel with temperature probe included and humidity probe on request

PNCSNDUMID00000

Controller to control ventilation units according to temperature degree and THI level.

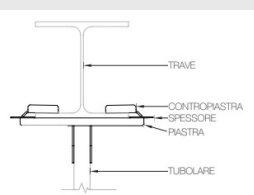

IPE/HEA/HEB beam fastening kit

KITIPEHEAHEB000

Fastening kit for SMHS fans in HVLS version compatible with most popular IPE, HEA, HEB steel profiles.



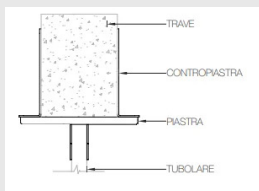

Fixing kit for rectangular section beams

KITRETTANGOL000

Fixing kit for SMHS fans in HVLS version compatible with rectangular section beams with base between 100mm and 260mm.



Related Products



HVLS industrial 5-blade ceiling fan APBG5S

SWHS000000000000

HVLS Industrial 5-Blade Ceiling Fan APBG5S

- 5 Blades Extruded Aluminum Shaped Profile
- Narrow Cone Air Distribution
- Three-phase Brushless EC motor equipped with Integrated Electronic System and EMC filters 3
- Sizes with Diameters 4m / 5m / 6m
- Air Flow Rates up to 529,464 m³/h (AMCA230-99)
- 120 RPM Max
- Pot. Max Ass. 1.4 kW
- Suitable for continuous duty S1



Industrial 3-blade ceiling fan HVLS3

SLHS000000000000

HVLS 3-Blade Industrial Ceiling Fans.

- 3 Blades Extruded in Anodized Aluminum against Corrosion with Constant Cross Section
- Precabled 3-phase Brushless EC motor equipped with Integrated Electronic System and EMC3 filters
- Sizes with Diameters 2.4m / 3m / 3.6m
- Air Flow Rates up to 134,271 m³/h (AMCA230-99)200
- Max RPM
- Pot. Max Ass. 0.7 kW
- Suitable for continuous duty S1.

